



OpenAir™

Air damper actuators

GDB...1
GLB...1

Rotary version, modulating, AC 24 V / AC 230 V

Electronic motor driven actuators for three-position and modulating control, nominal torque 5 Nm (GDB) or 10 Nm (GLB), mechanically adjustable span between 0...90°, pre-wired with 0.9 m long connection cables.

Type-specific variations with adjustable offset and span for the positioning signal, position indicator, feedback potentiometer and adjustable auxiliary switches for supplementary functions.

Remarks

This data sheet provides a brief overview of these actuators. Please refer to the Technical Basics in document Z4634E for a detailed description as well as information on safety, engineering notes, mounting and commissioning Z4634E.

Use

- For damper areas up to 0.8 m² (GDB) / 1.5 m² (GLB), friction-dependent
- Suitable for use with modulating controllers (DC 0...10 V) or three-position controllers for air dampers or air throttles.

Type summary

GDB.../GLB...	131.1E	132.1E	136.1E	331.1E	332.1E	336.1E	161.1E	163.1E	164.1E	166.1E
Control type	Three-position control						Modulating control			
Operating voltage AC 24 V	X	X	X				X	X	X	X
Operating voltage AC 230 V				X	X	X				
Positioning signal Y DC 0...10 V							X	X	X	X
DC 0...35 V with characteristic function $U_0, \Delta U$								X	X	
Position indicator $U = DC 0...10 V$							X	X	X	X
Feedback potentiometer 1 k Ω		X			X					
Self-adaption of rotational angle range							X	X	X	X
Auxiliary switches (two)			X			X			X	X
Rotary direction switch							X	X	X	X

Functions

Type	GDB.3..1 / GLB.3..1	GDB16..1 / GLB16..1
Control type	Three-position control	Modulating control
Positioning signal with adjustable characteristic function		DC 0...35 V at Offset $U_0 = 0...5 V$ Span $\Delta U = 2...30 V$
Rotary direction	Clockwise or counter-clockwise direction depends... ...the type of control. With no power applied, the actuator remains in the respective position.	
Position indication: Mechanical	Rotary angle position indication by using a position indicator.	
Position indication: Electrical	The feedback potentiometer can be connected to external voltage to indicate the position.	Position indicator: Output voltage $U = DC 0...10 V$ is generated proportional to the rotary angle. U depends on the rotary direction of the DIL switch setting.
Auxiliary switch	The switching points for auxiliary switches A and B can be set independent of each other in increments of 5° within 0° to 90°.	
Self-adaption of linear span		When self-adaption is active, the actuator automatically determines the mechanical end positions of the linear span and maps the characteristic function ($U_0, \Delta U$) to the calculated linear span.
Rotary angle limitation	The rotary angle of the shaft adapter can be limited mechanically at increments of 5°.	

Ordering





Note

Potentiometer and auxiliary switches **cannot be added in the field**. For this reason, order the type that includes the required options.

Accessories, spare parts

Accessories to functionally extend the actuators are available, e.g., rotary/linear sets, see data sheet **N4698**.

Technical data

 AC 24 V supply (SELV/PELV)	Operating voltage / Frequency	AC 24 V ± 20 % / 50/60 Hz	
	Power consumption GDB13..1/GLB13..1 Running	2 VA / 1 W	
	GDB16..1/GLB16..1 Running	3 VA / 2 W	
		1 W	
 AC 230 V supply	Operating voltage / Frequency	AC 230 V ± 10 % / 50/60 Hz	
	Power consumption GDB33..1/GLB33..1	2 VA / 1 W	
Function data	Nominal torque	5 Nm (GDB) / 10 Nm (GLB)	
	Maximum torque (blocked)	7 Nm (GDB) / 19 Nm (GLB)	
	Nominal rotary angle / Max. rotary angle	90° / 95° ± 2°	
	Runtime for 90° rotary angle	150 s (50 Hz) / 125 s (60 Hz)	
Positioning signal for GDB/GLB1	Input voltage Y (wires 8-2)	DC 0...10 V, int. limited of DC 10 V	
	Max. permissible input voltage	DC 35 V	
Characteristic functions GDB/GLB161.1, GDB/GLB166.1 GDB/GLB163.1, GDB/GLB164.1	Input voltage Y (wires 8-2)	DC 0...35 V	
	Non-adjustable characteristic function	DC 0...10 V	
	Adjustable characteristic function Offset U _o	DC 0...5 V	
	Span ΔU	DC 2...30 V	
Position indicator for GDB/GLB16...1	Output voltage U (wires 9-2)	DC 0...10 V or DC10...0 V	
	Max. output current	DC ± 1 mA	
Feedback potentiometer for GDB/GLB132.1, GDB/GLB332.1	Change of resistance (wires P1-P2)	0...1000 Ω	
	Load	< 1 W	
 Auxiliary switches for GDB../GLB..6.1, GDB/GLB164.1	Contact rating	6 A resistive, 2 A inductive	
	Voltage (no mixed operation AC 24 V / AC 230 V)	AC 24...230 V	
	Switching range for auxiliary switches	5°...90°	
	Setting increments	5°	
Connection cables	Cross-section	0.75 mm ²	
	Standard length	0.9 m	
Degree of protection of housing	Degree of protection as per EN 60 529 (note mounting instructions)	IP 54	
Protection class	Insulation class	EN 60 730	
	AC 24 V, feedback potentiometer	III	
	AC 230 V, auxiliary switch	II	
Environmental conditions	Operation / Transport	IEC 721-3-3 / IEC 721-3-2	
	Temperature	-30...+55 °C / -30...+60 °C	
	Humidity (non-condensing)	< 95% r. F. / < 95% r. F.	
Standards and directives	Product safety: Automatic electrical controls for household and similar use	EN 60 730-2-14 (Type 1)	
	Electromagnetic compatibility (EMC):		
	Immunity for all models, except GDB/GLB.32.1x	IEC/EN 61 000-6-2	
	Immunity for GDB/GLB.32.1x	IEC/EN 61 000-6-1	
	Emission for all types	IEC/EN 61 000-6-3	
	 Conformity:		
	Electromagnetic compatibility	89/336/EWG	
	Low voltage directive	73/23/EWG	
	 Conformity:		
	Australian EMC Framework	Radio Communication Act 1992	
Radio Interference Emission Standard	AS/NZS 3548		
Dimensions	Actuator W x H x D (see "Dimensions")	68 x 137 x 59.5 mm	
	Damper shaft:	round GDB	8...16 mm
		round GLB	8...10 mm with centering element
		round GLB	10...16 mm without centering element
	4-kant	6...12,8 mm	
	> Min. shaft length	30 mm	
	Shaft hardness	< 300 AV	
Weight	Without packaging: GDB... / GLB...	0.48 kg	

Disposal

The document on technical basics and the environmental declaration provide information on environmental compatibility and disposal of this device.

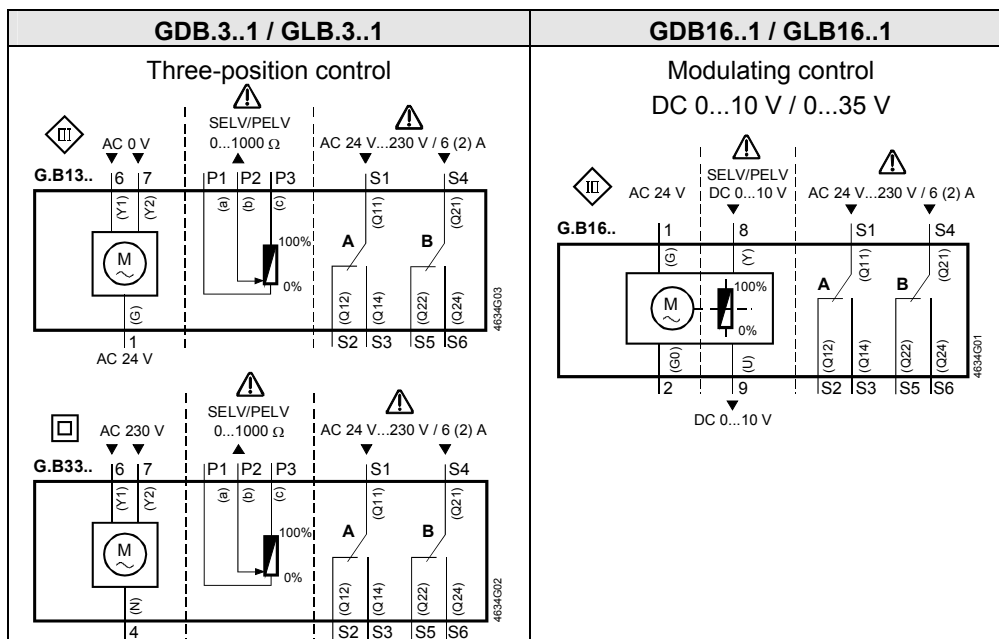

Cable labeling

Pin	Cable				Meaning
	Code	No.	Color	Abbreviation	
Actuators AC 24 V	G	1	red	RD	System potential AC 24 V
	G0	2	black	BK	System neutral
	Y1	6	purple	VT	Position signal AC 0 V, clockwise
	Y2	7	orange	OG	Position signal AC 0 V, counter-clockwise
	Y	8	grey	GY	Position signal DC 0...10 V, 0...35 V
	U	9	pink	PK	Position indication DC 0...10 V
Actuators AC 230V	N	4	blue	BU	Neutral conductor
	Y1	6	black	BK	Control signal AC 230 V, clockwise
	Y2	7	white	WH	Control signal AC 230 V, counter-clockwise
Auxiliary switch	Q11	S1	grey/red	GY RD	Switch A Input
	Q12	S2	grey/blue	GY BU	Switch A Normally closed contact
	Q14	S3	grey/pink	GY PK	Switch A Normally open contact
	Q21	S4	black/red	BK RD	Switch B Input
	Q22	S5	black /blue	BK BU	Switch B Normally closed contact
	Q24	S6	black /pink	BK PK	Switch B Normally open contact
Feedback potentiometer	a	P1	white /red	WH RD	Potentiometer 0...100 % (P1-P2)
	b	P2	white /blue	WH BU	Potentiometer pick-off
	c	P3	white /pink	WH PK	Potentiometer 100...0 % (P3-P2)

Dimensions

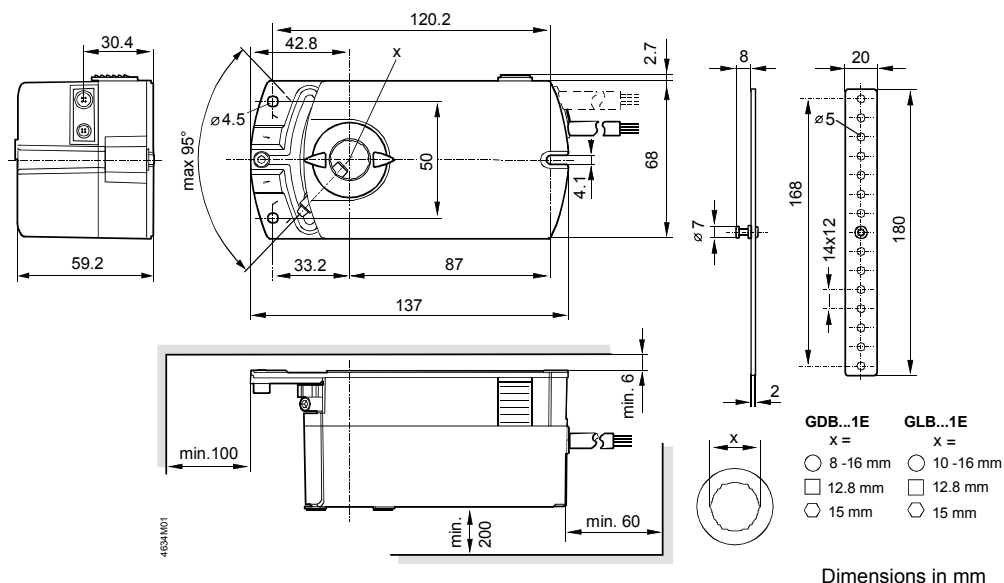

Dimensions in mm